

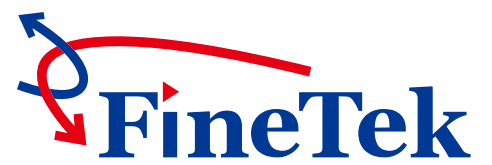

Tuning Fork Level Switch



www.fine-tek.com



PRODUCT INTRODUCTION

WORKING PRINCIPLE

The piezoelectric component is used to drive the tuning fork and feedback signal, which produces the resonance on the fork. When the fork comes into contact with a material, the fork will release some frequency signal as feedback. It will be converted into the output of the contact signal when the circuit detects the frequency decrease of the signal.

The product relies on the damping effect by covering the testing material on the tuning fork which reduces the vibration frequency of the tuning fork and outputs a switch signal. Therefore, there is no signal amplification circuit inside, which can eliminate the trouble of frequent sensitivity adjustment due to the material change.

FEATURE

- SPDT Relay output, SSR MOSFET output.
- Wide voltage supply range 20~250 Vac/Vdc,50/60Hz
- No frequent calibration required, easy-to-use, sturdy and durable design. High/low failure safe mode, safe and reliable.
- Sensitivity adjustment is available for different densities of media. Fine powder can be detected.
- Suitable for liquid, powder, and solid application.
- Dual insulation can reduce damage on the PCB board caused by great changes in temperature and humidity, as well as condensation effects (SC3□ series).
- It can be tested by pressing the test button after installation (SC3□ series).
- Output switch delay function (SC3□ series).
- Self-diagnosis mechanism can detect the abnormality such as the abrasion of the tuning fork or the material viscosity (SC3□ series).
- The compact built-in wiring box can save the installation space (SC3□ series).
- The wiring box can rotate 270 degrees, facilitating adjustment of the inlet direction (SC3□ series).
- The minimum measurable specific gravity can reach 0.01 g/cm³ (SC35 series).
- Ultra protection mechanism can set the secondary output contact point as alarm output (SC35 series).
- Support the function of detecting underwater sediments (SC35 series).
- All-in-one design, 3/4" (SC38 series) 、 1" (SC39 series) thread is suitable for the installation of a small tube.
- Adjustment setting for different densities of media $\rho > 0.5 \text{ g/cm}^3$ or $\rho < 0.7 \text{ g/cm}^3$ (SC38 & 39 series).
- Switch delay setting function (SC3□ series).
- Alarm indicators based on failure status or output status selected according to the customer's habits (SC3□ series).
- Automatic calibration of the operation points for different densities of media as required by the customer (SC38 & 39 series).

APPLICABLE MATERIALS

The tuning fork level switch can be widely applied to detect the min. and max. level in tanks, silos and hoppers filled with materials of different densities and state. The following list shows its applications.

POWDER

- | | |
|------------------------|------------------------|
| 1. Powdered milk | 15. Pellets |
| 2. Frozen potato chips | 16. Peanuts |
| 3. Beans | 17. Tobacco |
| 4. Sugar | 18. Wood shavings |
| 5. Sweets | 19. Chalk |
| 6. Coffee beans | 20. Stearin chips |
| 7. Coffee powder | 21. Powdered cellulose |
| 8. Frozen dry coffee | 22. Glass fine power |
| 9. Tea | 23. Granular plastics |
| 10. Salt | 24. Gravel |
| 11. Flour | 25. Powdered clay |
| 12. Foundry sand | 26. Polystyrene powder |
| 13. Spices | 27. Styrofoam |
| 14. Animal food | 28. Soda |

LIQUID

1. Water & Solutions
2. General Purpose Solvent
3. Soy sauce
4. Heavy oil
5. Petroleum
6. Oil
7. Ink
8. Cream
9. Drink & Beverage
10. Corrosive liquid

APPLICATION SCOPE

It is applicable to the max. and min. level detection of the tanks or tubes filled with various solid/liquid media. The product has a variety of applications, such as in the chemical fiber industry, rubber industry, tire industry, cement industry, steel industry, food industry, pharmaceutical industry, and animal feed factories in terms of the level detection for the bins of the raw material/process/finished products.

LITE-TYPE

<p>Dimensions (Unit:mm)</p>			
<p>Model no.</p>	<p>SC2400/2410 【DIN Connector】</p>	<p>SC2400/2410 【M12 Connector】</p>	<p>SC2400/2410 【Cable Wire Type】</p>
<p>Supply voltage & output</p>	<p>SC240 □□:20~250Vac / Vdc 2 wire Contactless electronic switch. SC241□□:12~55 Vdc 3 wire PNP/ NPN Output.</p>		
<p>Fork length</p>	<p>100mm</p>		
<p>Ambient temp.</p>	<p>-40~80°C</p>		
<p>Ambient humidity</p>	<p>80% RH non-condensed</p>		
<p>Storage temp.</p>	<p>-40~85°C</p>		
<p>Process temp.</p>	<p>SC24□□□T: -40~+150°C SC24□□□: -40~+100°C</p>		
<p>Process pressure</p>	<p>Maximum 40 Bar</p>		
<p>Min. material density sensed</p>	<p>Solid:density: $\geq 0.07\text{g/cm}^3$ Liquid:density: $\geq 0.7\text{g/cm}^3$ Viscosity: 1~10000 cSt</p>		
<p>Magnetic testing</p>	<p>Output function test performed by putting magnets near the indicated spot</p>		
<p>Vibrating frequency</p>	<p>350~370Hz</p>		
<p>Status indication</p>	<p>Green light:indicate power supply Red light:indicate operating mode</p>		
<p>Housing material</p>	<p>SUS304</p>		
<p>Fork material</p>	<p>SUS304, SUS316, SUS316L</p>		
<p>IP protection</p>	<p>IP65</p>	<p>IP67</p>	<p>IP67</p>
<p>Mounting</p>	<p>1" more</p>		
<p>Conduit</p>	<p>Valve plug DIN 43650</p>	<p>M12x1 Connector(180° / 90°)</p>	<p>Cable connector</p>

MINI-TYPE

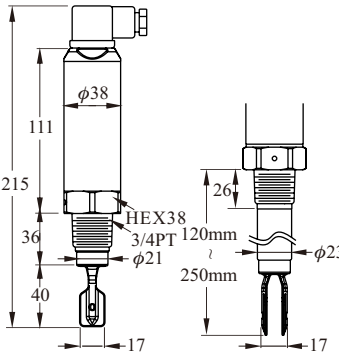
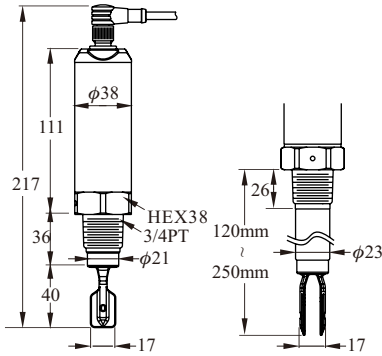
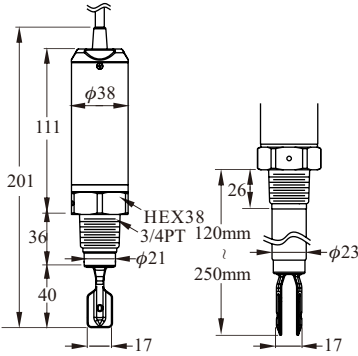
<p>Dimensions (Unit:mm)</p>	 <p>Standard Type Extension Type</p>	 <p>Standard Type Extension Type</p>	 <p>Standard Type Extension Type</p>
<p>Model no.</p>	<p>SC2800/2810 【DIN Connector】</p>	<p>SC2800/2810 【M12 Connector】</p>	<p>SC2800/2810 【Cable Wire Type】</p>
<p>Supply voltage & output</p>	<p>SC280□:20~250,50/60Hz Vac/Vdc 2 wire Contactless electronic switch. SC281□:12~55 Vdc 3 wire PNP/ NPN Output</p>		
<p>Fork length</p>	<p>40mm</p>		
<p>Ambient temp.</p>	<p>-40°C~80°C</p>		
<p>Ambient humidity</p>	<p>80% RH non-condensed</p>		
<p>Storage temp.</p>	<p>-40°C~85°C</p>		
<p>Process temp.</p>	<p>SC28□□□: -40°C~100°C SC28□□□T: -40°C~150°C</p>		
<p>Process pressure</p>	<p>-1~600PSI (40BAR)</p>		
<p>Min. material density sensed</p>	<p>Liquid:density: $\geq 0.7\text{g/cm}^3$ Viscosity: 1~10000 cSt</p>		
<p>Magnetic testing</p>	<p>Output function test performed by putting magnets near the indicated spot</p>		
<p>Vibrating frequency</p>	<p>1 KHz \pm 10%</p>		
<p>Status indication</p>	<p>Green light:indicate power supply Red light:indicate operating mode</p>		
<p>Housing material</p>	<p>SUS304</p>		
<p>Fork material</p>	<p>SUS304, SUS316, SUS316L</p>		
<p>IP protection</p>	<p>IP65</p>	<p>IP67</p>	<p>IP67</p>
<p>Mounting</p>	<p>3/4"more</p>		
<p>Conduit</p>	<p>Valve plug DIN 43650</p>	<p>M12x1 Connector(180° / 90°)</p>	<p>Cable connector</p>

STANDARD TYPE

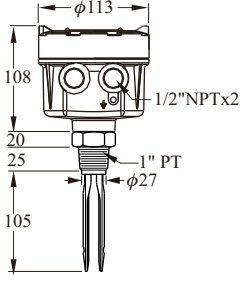
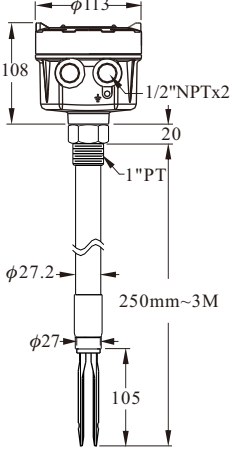
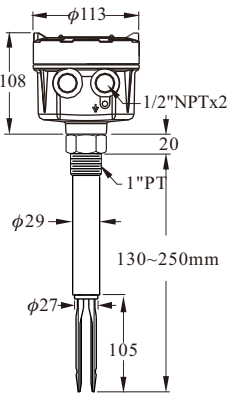
<p>Dimensions (Unit:mm)</p>			
<p>Model No.</p>	<p>SC1400 【 Standard Type 】</p>	<p>SC1410 【 Tuning Fork Ultra Extension Type 】</p>	<p>SC1420 【 Tuning Fork Extension Type 】</p>
<p>Level sensor housing</p>	<p>Aluminum / IP65</p>		
<p>Probe construction</p>	<p>SUS 304 / 316 / 316L</p>		
<p>Mounting</p>	<p>1"PT</p>		
<p>Conduit</p>	<p>1/2"NPT×2</p>		
<p>Max. vertical load on rod.</p>	<p>177in.Lbs(20Nm)</p>		
<p>Process pressure.</p>	<p>-1~600PSI (40BAR)</p>		
<p>Power supply</p>	<p>20~250Vac/Vdc,50/60Hz</p>		
<p>Power consumption</p>	<p>10VA</p>		
<p>Ambient temp.</p>	<p>-40°C~60°C</p>		
<p>Process temp.</p>	<p>-40°C~130°C</p>		
<p>Signal output</p>	<p>Relay, SPDT, 5A/250Vac/ 28Vdc, 1 set or 2 set SSR(MOSFET) 400mA/60 Vac/ Vdc, 1 set or 2 set</p>		
<p>Min. material density sensed</p>	<p>Solid:≥0.07g/cm³, Liquid: ≥0.7g/cm³</p>		
<p>Time delay</p>	<p>0.6 Second / Operate; 1~3 Seconds / Reset</p>		
<p>Vibrating frequency.</p>	<p>350~370Hz</p>		
<p>Selectable Fail-safe</p>	<p>Hi./ Lo.</p>		
<p>Selectable sensitivity</p>	<p>Hi./ Lo.</p>		

STANDARD TYPE

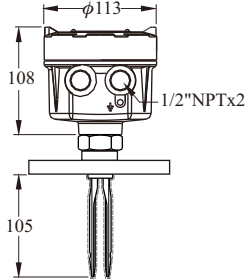
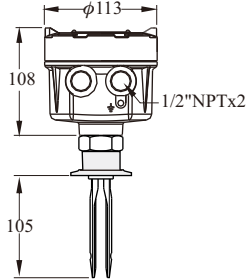
<p>Dimensions (Unit:mm)</p>		
<p>Model No.</p>	<p>SC1540 【Corrosion Proof Type】</p>	<p>SC1600 【Sanitary Type】</p>
<p>Level sensor housing</p>	<p>Aluminum / IP65</p>	
<p>Probe construction</p>	<p>316L Coating TEFLON</p>	<p>316L</p>
<p>Mounting</p>	<p>1" Flange (min.)</p>	<p>2" Sanitary</p>
<p>Conduit</p>	<p>1/2"NPT×2</p>	
<p>Max. vertical load on rod.</p>	<p>177in.Lbs(20Nm)</p>	
<p>Process pressure.</p>	<p>-1~600PSI (40BAR)</p>	
<p>Power supply</p>	<p>20~250Vac/dc, 50/60Hz</p>	
<p>Power Consumption</p>	<p>10VA</p>	
<p>Ambient temp.</p>	<p>-40°C~60°C</p>	
<p>Process temp.</p>	<p>-40°C~130°C</p>	
<p>Signal output</p>	<p>Relay, SPDT, 5A/250Vac/ 28Vdc, 1 set or 2 set SSR(MOSFET) 400mA/60 Vac/ Vdc, 1 set or 2 set</p>	
<p>Min. material density sensed</p>	<p>Solid: $\geq 0.07\text{g/cm}^3$, Liquid: $\geq 0.7\text{g/cm}^3$</p>	
<p>Time delay</p>	<p>0.6 Second / Operate; 1~3 Seconds / Reset</p>	
<p>Vibrating frequency.</p>	<p>350~370Hz</p>	
<p>Selectable Fail-safe</p>	<p>Hi./ Lo.</p>	
<p>Selectable sensitivity</p>	<p>Hi./ Lo.</p>	

EX-PROOF TYPE

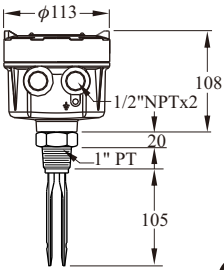
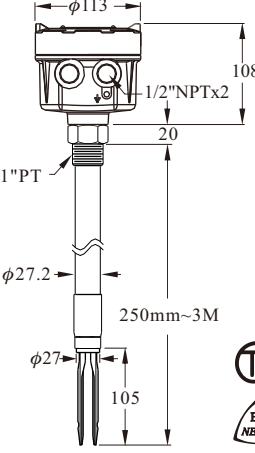
<p>Dimensions (Unit:mm)</p>		
<p>Model No.</p>	<p>SC1740 【Standard Type】</p>	<p>SC1741 【Tuning Fork Ultra Extension Type】</p>
<p>Level sensor housing</p>	<p>Aluminum</p>	
<p>Probe construction</p>	<p>SUS 304 / 316 / 316L</p>	
<p>Mounting</p>	<p>1"PT</p>	<p>1"PT</p>
<p>Conduit</p>	<p>1/2"NPT×2</p>	
<p>Max. vertical load on rod.</p>	<p>177in.Lbs(20Nm)</p>	
<p>Process pressure.</p>	<p>-1~600PSI (40BAR)</p>	
<p>Power supply</p>	<p>20~250,50/60Hz Vac/Vdc</p>	
<p>Power consumption</p>	<p>10VA</p>	
<p>Ambient temp.</p>	<p>-20°C~70°C</p>	
<p>Process temp.</p>	<p>-40°C~130°C</p>	
<p>Signal output</p>	<p>Relay, SPDT, 3A/250Vac/ 28Vdc, 1 set or 2 set SSR(MOSFET) 400mA/60 Vac/ Vdc, 1 set or 2 set</p>	
<p>Min. material density sensed</p>	<p>Solid: ≥0.07g/cm³, Liquid: ≥0.7g/cm³, viscosity : 1~10000 cst</p>	
<p>Time delay</p>	<p>0.6 Second / Operate; 1~3 Seconds / Reset</p>	
<p>Vibrating frequency.</p>	<p>350~370Hz</p>	
<p>Selectable Fail-safe</p>	<p>Hi./ Lo.</p>	
<p>Selectable sensitivity</p>	<p>Hi./ Lo.</p>	

SC35 TUNING FORK LEVEL SWITCH

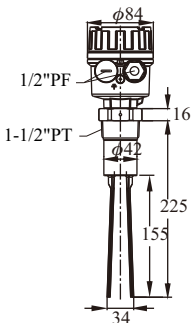
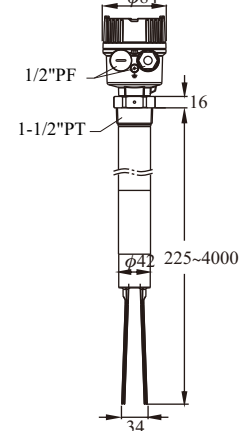
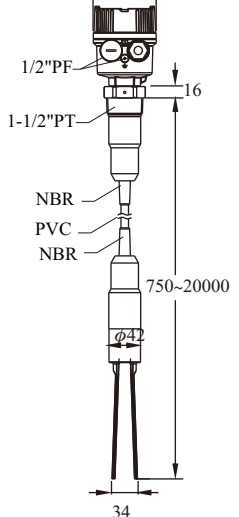
<p>Dimensions (Unit:mm)</p>			
<p>Model No.</p>	<p>SC350 【Standard Type】</p>	<p>SC351 【Extension Type】</p>	<p>SC352 【Cable Type】</p>
<p>Level sensor housing</p>	<p>Built-in box, aluminum coating IP66/IP67</p>		
<p>Power supply</p>	<p>19 ~253 Vdc / Vac, 50/60 Hz ; NPN / PNP(10~55Vdc)</p>		
<p>Probe construction</p>	<p>Max. 1.5 W</p>		
<p>Voltage endurance capability</p>	<p>3.7 kV</p>		
<p>Overvoltage protection</p>	<p>overvoltage category II</p>		
<p>Storage temp.</p>	<p>-40~85 °C</p>		
<p>Ambient temp.</p>	<p>-40~85 °C</p>		<p>-40~75 °C</p>
<p>Process temp.</p>	<p>-40~150 °C</p>	<p>-40~150 °C</p>	<p>-40~80 °C</p>
<p>Material density</p>	<p>≥ 0.01 g/cm³ or ≥ 0.05 g/cm³</p>		
<p>Measuring frequency</p>	<p>140 Hz ± 5 Hz</p>		
<p>Material dimension</p>	<p>Max.10 mm</p>		
<p>Conduit</p>	<p>1/2"PF / 1/2"NPT(Ex-proof type only supports 1/2"NPT)</p>		
<p>External diameter of cable applicable to conduit</p>	<p>φ6~φ10 mm</p>		
<p>Pressure resistance</p>	<p>Max.25 Bar</p>		<p>Max. 2 Bar</p>
<p>Output signal</p>	<p>2 sets of SPDT relay output/2 sets of transistor output / 3 wires NPN/PNP transistor output</p>		
<p>Contact capacity</p>	<p>Relay: 6A / 250Vac , 6A / 28Vdc ; Transistor: 350mA , 60Vac / Vdc NPN / PNP / Transistor: 350mA , 55Vdc</p>		
<p>Ex-proof certification</p>	<p>Dust ex-proof (DIP A20/21 T_A , T₂~T₆ IP66/67, optional)</p>		

SC35 TUNING FORK LEVEL SWITCH

Dimensions (Unit:mm)		
Model No.	SC350 [High-temp. Type]	SC351 [High-temp. Extension Type]
Level sensor housing	Built-in box, aluminum coating IP66/IP67	
Power supply	19 ~253 Vdc / Vac, 50/60 Hz	
Probe construction	Max. 1.5 W	
Voltage endurance capability	3.7 kV	
Overvoltage protection	overvoltage category II	
Storage temp.	-40~85 °C	
Ambient temp.	-40~85 °C	
Process temp.	-40~280 °C	
Material density	≥ 0.01 g/cm ³ or ≥ 0.05 g/cm ³	
Measuring frequency	140 Hz ± 5 Hz	
Material dimension	Max.10 mm	
Conduit	1/2"PF / 1/2"NPT(Ex-proof type only supports 1/2"NPT)	
External diameter of cable applicable to conduit	φ6~φ10 mm	
Pressure resistance	Max. 25 Bar	
Output signal	2 sets of SPDT relay output/2 sets of transistor output	
Contact capacity	Relay: 6A / 250Vac , 6A / 28Vdc Transistor: 350mA , 60Vac / Vdc	
Ex-proof certification	Dust ex-proof (DIP A20/21 T _A , T2~T6 IP66/67, optional)	



SC38 MULTI-FUNCTIONAL TUNING FORK LEVEL SWITCH

NEPSI PROOF No.GYB14.1796X
Ex ia IIC T3~T6 Ga

※ Output type is 8/16mA current output type has certified by NESI Explosion

Dimensions (Unit:mm)				
	<p style="text-align: center;">SC380 【Standard Type】</p> <p style="text-align: center;">SC381 【Extension Type】</p> <p style="text-align: center;">SC382 【Ultra Extension Type】</p>			
	Output type	8/16mA output type	3 wires (NPN/PNP) output type	Dual-relay output type
	Working voltage	11 ~36 Vdc	10 ~55 Vdc	19~253Vac/dc,50/60Hz
Power consumption	< 600mW	< 830mW	Max. 1.3W	
Input protection	Reversed power supply protection function		NA	
Overvoltage protection	overvoltage category III			
Measuring error	Max.±1mm			
Repeatability	0.5mm			
Hysteresis band	Approx.2mm			
Storage temp.	-40~85 °C			
Ambient temp.	-40~85 °C (Intrinsically safe type-40~70 °C)	-40~85 °C(Refernce operation manual)		
Process temp.	-40~150 °C (Refernce operation manual)			
Applicable density liquid	≥0.5 g/cm ³ or ≥0.7 g/cm ³			
Liquid viscosity	Max.10000mm ² / S(10000cst)			
Granule size contained in the liquid	Max.φ5 mm			
External diameter of cable applicable to conduit	φ6~φ10 mm			
Pressure resistance	Max.40 Bar			
Output signal	Intrinsically safe signal 8/16mA	Transistor output (NPN/PNP)	2 sets of SPDT relay output	
Contact capacity	NA	350mA , 55Vdc	6A / 250Vac , 6A / 28Vdc	
Protection level	IP66/67			
Intrinsically safe parameters	Ui(V)=36V , Ii=100mA, Pi=1W Ci(nF)=0 , Li(uH)=0	NA	NA	

※It shall combine with the ex-proof fence meeting level Ex ia to form the intrinsically safe system. Please refer to page 27 for more details.

SC38 MULTI-FUNCTIONAL TUNING FORK LEVEL SWITCH

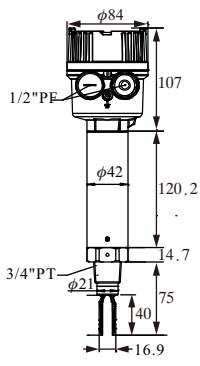
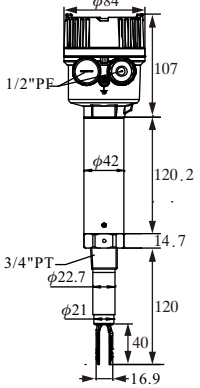
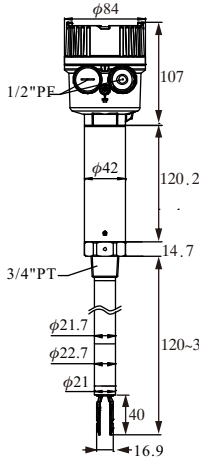
Dimensions (Unit:mm)	 <p style="text-align: center;">SC380 【High-temp. Type】</p>	 <p style="text-align: center;">SC381 【High-temp. Extension Type】</p>	 <p style="text-align: center;">SC382 【High-temp. Extension Type】</p>
Output type	8/16mA output type	3 wires (NPN/PNP) output type	Dual-relay output type
Working voltage	11 ~36 Vdc	10 ~55 Vdc	19~253Vac/dc,50/60Hz
Power consumption	< 600mW	< 830mW	Max. 1.3W
Input protection	Reversed power supply protection function		NA
Overvoltage protection	overvoltage category III		
Measuring error	Max.±1mm		
Repeatability	0.5mm		
Hysteresis band	Approx.2mm		
Storage temp.	-40~85 °C		
Ambient temp.	-40~85 °C(Refernce operation manual)		
Process temp.	-40~150 °C		
Applicable density liquid	≥0.5 g/cm ³ or ≥0.7 g/cm ³		
Liquid viscosity	Max.10000mm ² / S(10000cst)		
Granule size contained in the liquid	Max.φ5 mm		
External diameter of cable applicable to conduit	φ6~φ10 mm		
Pressure resistance	Max.40 Bar		
Output signal	Intrinsically safe signal 8/16mA	Transistor output (NPN/PNP)	2 sets of SPDT relay output
Contact capacity	NA	350mA , 55Vdc	6A / 250Vac , 6A / 28Vdc
Protection level	IP66/67		
Intrinsically safe parameters	Ui(V)=36V , li=100mA,Pi=1W Ci(nF)=0 , Li(uH)=0	NA	NA

※It shall combine with the ex-proof fence meeting level Ex ia to form the intrinsically safe system. Please refer to page 27 for more details.

SC39 MULTI-FUNCTIONAL TUNING FORK LEVEL SWITCH

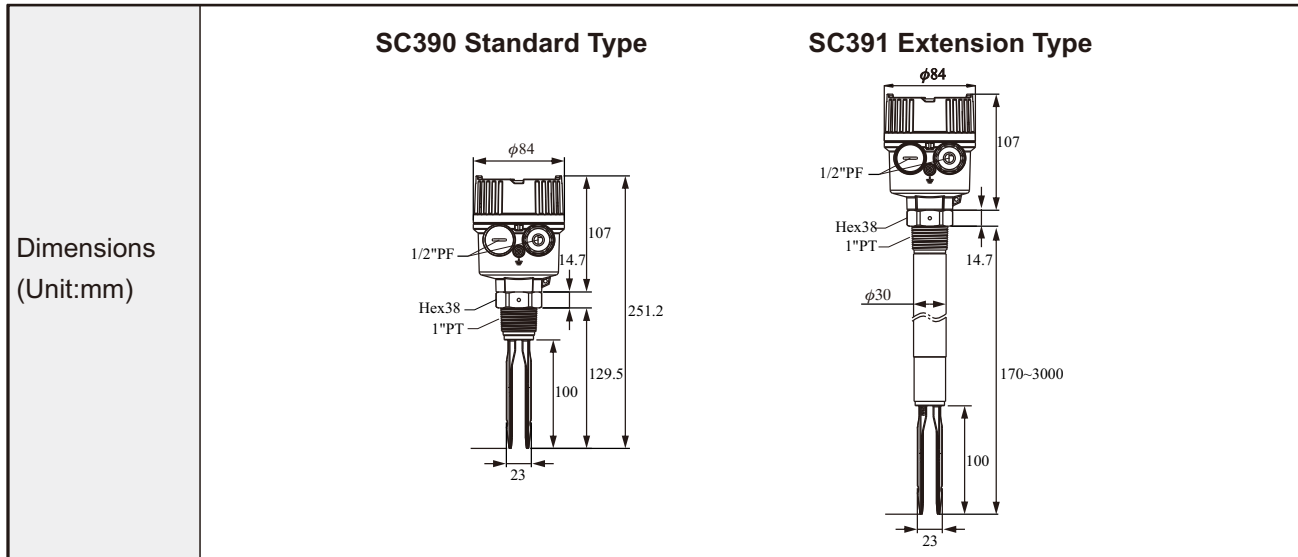

Output type	8/16mA output type	3 wires (NPN/PNP) output type	Dual-relay output type	Dual-MOSFET output type
Working voltage	11 ~36 Vdc	10 ~55Vdc	19 ~253Vac/dc, 50/60Hz	19 ~253Vac/dc, 50/60Hz
Power consumption	< 600mW	< 830mW	Max. 1.3W	Max. 1.3W
Input protection	Reversed power supply protection function		NA	NA
Overtoltage protection	overtoltage category III			
Hysteresis band	Approx.5mm			
Ambient temp.	-40~85 °C (Refernce operation manual)			
Process temp.	-40~150 °C (Refernce operation manual)			
Applicable density liquid	$\geq 0.5 \text{ g/cm}^3$ or $\geq 0.7 \text{ g/cm}^3$			
Liquid viscosity	Max.10000mm ² / S(10000cst)			
External diameter of cable applicable to conduit	$\phi 6 \sim \phi 10 \text{ mm}$			
Pressure resistance	Max.60Bar			
Output signal	Intrinsically safe signal 8 / 16mA	Transistor output NPN / PNP	2 sets of SPDT relay output	MOSFET SPST×2
Contact capacity	NA	350mA · 55Vdc	6A/250Vac/28Vdc	350mA · 60Vac/dc
Protection level	IP66/67			

SC39 MULTI-FUNCTIONAL TUNING FORK LEVEL SWITCH

Dimensions (Unit:mm)	SC390 High-temp. Type	SC391 High-temp. Extension Type

Output type	8/16mA output type	3 wires (NPN/PNP) output type	Dual-relay output type	Dual-MOSFET output type
Working voltage	11 ~36 Vdc	10 ~55Vdc	19 ~253Vac/dc, 50/60Hz	19 ~253Vac/dc, 50/60Hz
Power consumption	< 600mW	< 830mW	Max. 1.3W	Max. 1.3W
Input protection	Reversed power supply protection function		NA	
Overvoltage protection	overvoltage category III			
Hysteresis band	Approx.5mm			
Ambient temp.	-40~85 °C (Refernce operation manual)			
Process temp.	-40~150 °C			
Applicable density liquid	$\geq 0.5 \text{ g/cm}^3$ or $\geq 0.7 \text{ g/cm}^3$			
Liquid viscosity	Max.10000mm ² / S(10000cst)			
External diameter of cable applicable to conduit	$\phi 6 \sim \phi 10 \text{ mm}$			
Pressure resistance	Max.60Bar			
Output signal	Intrinsically safe signal 8 / 16mA	Transistor output NPN / PNP	2 sets of SPDT relay output	MOSFET SPST×2
Contact capacity	NA	350mA · 55Vdc	6A/250Vac/28Vdc	350mA · 60Vac/dc
Protection level	IP66/67			

WIRING INSTRUCTIONS (STANDARD TYPE)

SC1400X, SC1410X, SC1420X, SC1540X, SC1600X, SC1740X, SC1741X

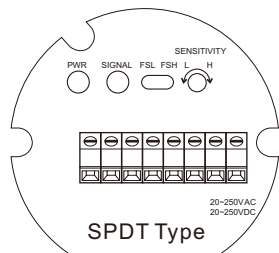

Relay output type(SPDT)



RT2 RT1 NC COM NO N- L+ \perp

SSR(MOSFET) output type

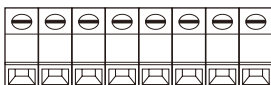

RT2 RT1 COM NO N- L+ \perp

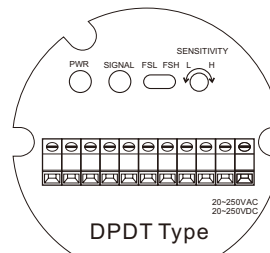

Relay output type (DPDT)

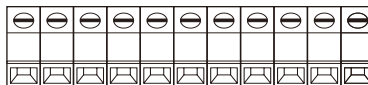

RT2 RT1 COM2 NC2 NO2 COM1 NC1 NO1 N- L+ \perp

SSR(MOSFET) output type

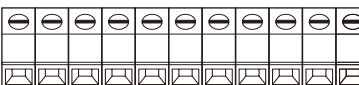

RT2 RT1 COM2 NO2 COM1 NO1 N- L+ \perp

FUNCTIONAL DESCRIPTION

Description of terminal functions

- L+, N-: Power Supply
- NC, COM, NO: Relay Output
- RT1, RT2: Remote-Test
- \perp : Ground Connection
- COM1, NO1 : SSR(MOSFET) Output
- COM2, NO2 : The second set of SSR (MOSFET) output (Optional)

DESCRIPTION OF PANEL FUNCTIONS

- PWR: Power Supply (Green Light)
- SIGNAL: Output Indication (Red Light)
- FSH: Power On. The signal lamp is on and the relay is conductive. While the tuning fork switch senses the material, the signal lamp is off and relay is not conductive.
- FSL: Power On. The signal lamp is off and the relay is not conductive. While the tuning fork switch senses the material, the signal lamp is on and relay is conductive.
- SENSITIVITY L: Low Sensitivity
- SENSITIVITY H: High Sensitivity

FAIL-SAFE HIGH / LOW PROTECTION

FSH (Fail-Safe High) Protection:

Switch to FSH mode.

Normal Status: The signal lamp is on. It indicates that the tuning fork switch does not sense the material and the relay is conductive.

Failure: When the power shuts down, the signal lamp is off. It indicates that the tuning fork switch is voided and the relay is not conductive.

FSL (Fail-Safe Low) Protection:

Switch to FSL mode.

Normal Status: The signal lamp is on.

The tuning fork switch senses the material and the relay is conductive.

Failure: When the power shuts down, the signal lamp is off. The tuning fork switch is voided and the relay is not conductive.

SENSITIVITY ADJUSTMENT

The SENSITIVITY is located on the right side of the panel. The user is able to do the minor adjustment by the screw driver when it rotates for 22 turns. If it turns to H position clockwise, the sensitivity increases; if it turns to L position anti-clockwise, the sensitivity decreases. The sensitivity is originally set at max. value. The switching point is at 15mm from the tip of the tuning fork. The switching point position will be changed by the sensitivity value. If the sensitivity adjusts to lower value, the switching point position is moving backward; if the sensitivity adjusts to high value, the switching point position is moving forward. User may change the switching point position by adjusting the sensitivity. The changing range of switching point is about 60mm. For example, if the switching point needs to be moved backward by 30mm, the user needs to adjust SENSITIVITY anti-clockwise by 10 turns. In general cases, there is no need for sensitivity adjustment.

	FSL		FSH	
Level				
Contact form	NO COM NC	NO COM NC	NO COM NC	NO COM NC
Indication	○	☀	☀	○
Status	Fail	Normal	Normal	Fail

WIRING INSTRUCTIONS (LITE-TYPE/MINI-TYPE)

SC240X/SC280(Two wires) WIRING

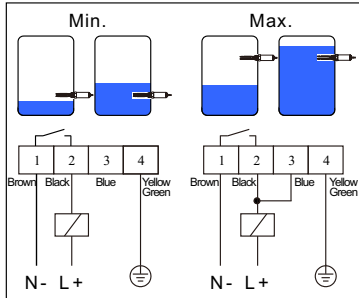
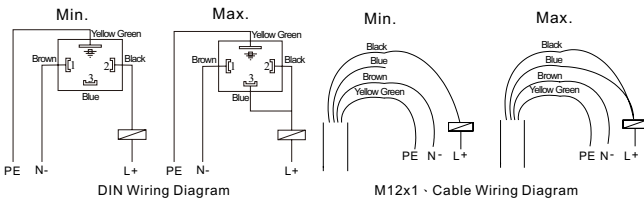

Figure 1 Two wires wiring



Wiring

Power can be AC/DC switching. Two wires are connected with terminals (L+/N-) as in Figure 1.

Low (Min.) Mode:

Pin 1 (Brown) is connected to N-. Pin 2 (Black) is connected to L+ with relay. Pin 4 (Yellow Green) connects to tank ground.

High (Max.) mode:

Pin 1 (Brown) is connected to N-. Pin 3 is connected to pin 2 (Black) to L+ with Relay. Pin 4 (Yellow Green) connects to tank ground.

SC241X/SC281(Three wires) WIRING

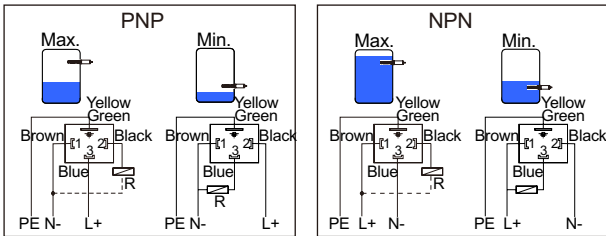

DIN Wiring Diagram

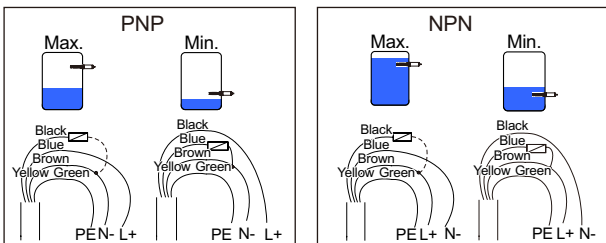

M12x1 Cable Wiring Diagram

Figure 2 PNP / NPN Output Wiring Diagram

Wiring

Power supply is for DC only. Output is PNP / NPN. Please see Figure 2.

PNP wiring :

High(Max.) Mode:

Pin 1(Brown) connects to N-. Pin 3 (Blue) connects to L+. To output, it is pin 2. (Black) connects to N- with relay. Pin 4 (Yellow Green) connects to tank ground.

Low(Min.)Mode:

Pin 1 (Brown) connects to N-. Pin 2 (Black) connects to L+. To output, Pin 3 (Blue) connects to N- with relay. Pin 4 (Yellow Green) should contact to tank ground.

NPN wiring :

High(Max.) Mode:

Pin 1 (Brown) connects to L+. Pin 3 (Blue) connects to N-. To output, Pin 2 (Black) connects to L+ with relay. Pin 4 (Yellow Green) should contact to tank ground.

Low(Min.)Mode:

Pin1 (Brown) connects to L+. Pin 2 (Black) connects to N-. To output Pin 3 (Blue) connects to L+ with relay. Pin 4 (Yellow Green) should contact to tank ground.

WIRING INSTRUCTIONS (SC35)

WIRING CONFIGURATION DIAGRAM AND INTRODUCTION OF FEATURES

Dual-relay output

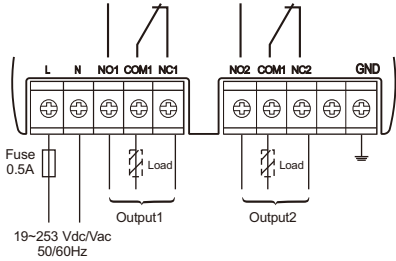

Load: External load
 $U \sim \text{max. } 250\text{Vac}@I_L \sim \text{max. } 6\text{A}$
 $U = \text{max. } 28\text{Vdc}@I_L = \text{max. } 6\text{A}$

Failure mode	Material level	Output signal			LED indicators		
		output1	output2		Power	Status	Alarm
			S.S. OFF	S.S. ON	Green	Yellow	Red
MAX						$\text{o.s. } \begin{matrix} \text{ON} \\ \text{OFF} \end{matrix}$	
						$\text{o.s. } \begin{matrix} \text{OFF} \\ \text{ON} \end{matrix}$	
MIN						$\text{o.s. } \begin{matrix} \text{ON} \\ \text{OFF} \end{matrix}$	
						$\text{o.s. } \begin{matrix} \text{OFF} \\ \text{ON} \end{matrix}$	
Viscous material		Maintain the previous state				$\text{o.s. } \begin{matrix} \text{OFF} \\ \text{ON} \end{matrix}$	
Wear of tuning fork							

Dual-transistor output

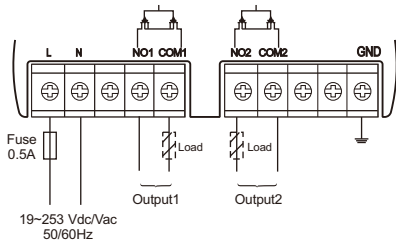

Load: External load
 $U \sim \text{max. } 60\text{Vac}@I_L \sim \text{max. } 350\text{mA}$
 $U = \text{max. } 60\text{Vdc}@I_L = \text{max. } 350\text{mA}$
 ※ External load R must be connected

Failure mode	Material level	Output signal			LED indicators		
		output1	output2		Power	Status	Alarm
			S.S. OFF	S.S. ON	Green	Yellow	Red
MAX						$\text{o.s. } \begin{matrix} \text{ON} \\ \text{OFF} \end{matrix}$	
						$\text{o.s. } \begin{matrix} \text{OFF} \\ \text{ON} \end{matrix}$	
MIN						$\text{o.s. } \begin{matrix} \text{ON} \\ \text{OFF} \end{matrix}$	
						$\text{o.s. } \begin{matrix} \text{OFF} \\ \text{ON} \end{matrix}$	
Viscous material		Maintain the previous state				$\text{o.s. } \begin{matrix} \text{OFF} \\ \text{ON} \end{matrix}$	
Wear of tuning fork							
Output1>350mA			Maintain the previous state				
Output2>350mA		Maintain the previous state					
Output1 & Output2>350mA							

※ When output is off, there will be no error current status

: ON : Flash : OFF

: Relay ON : Relay OFF I_L : Load current

WIRING INSTRUCTIONS (SC38 & SC39)

WIRING CONFIGURATION DIAGRAM AND INTRODUCTION OF FEATURES

8/16mA output

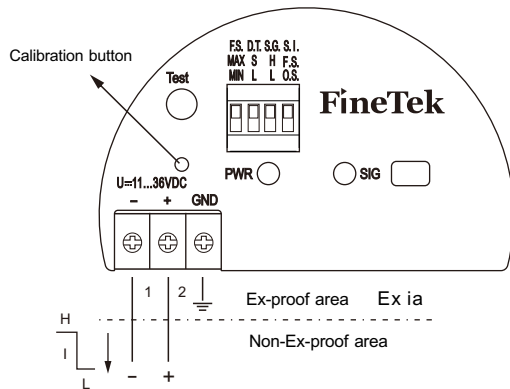

PNP/NPN Output

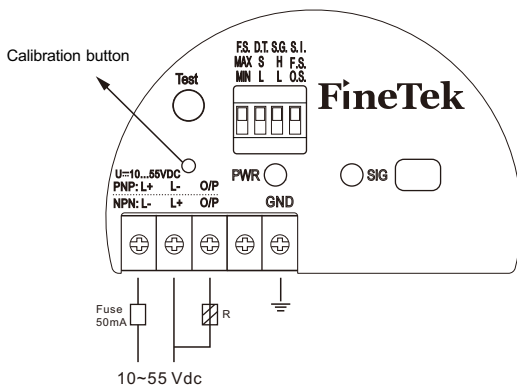

Dual Relay output

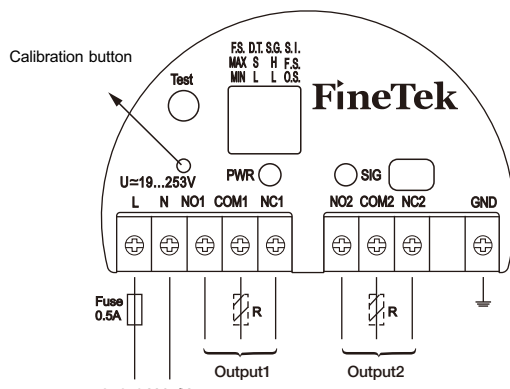

Failure mode	Material level	Output signal	LED indicators
MAX		+ ~16mA → 1	☀ O.S. ☀ F.S. ○
		+ ~8mA → 1	☀ O.S. ○ F.S. ☀
MIN		+ ~16mA → 1	☀ O.S. ☀ F.S. ○
		+ ~8mA → 1	☀ O.S. ○ F.S. ☀
Instrument failure		+ <3.6mA → 1	☀ ☀

~16mA=16mA ±5%
~8mA=8mA ±5%

☀ : ON ☀ : Flash ○ : OFF

Failure mode	Material level	Output signal	LED indicators
MAX		□ → I _L → □	☀ O.S. ☀ F.S. ○
		□ → <100μA → □	☀ O.S. ○ F.S. ☀
MIN		□ → I _L → □	☀ O.S. ☀ F.S. ○
		□ → <100μA → □	☀ O.S. ○ F.S. ☀
Instrument failure		□ → <100μA → □	☀ ☀
Over Load(I _L >350mA)		□ → <100μA → □	☀ ☀

I_L : Load current

☀ : ON ☀ : Flash ○ : OFF

R : External load
U = max. 55Vdc@I_L = max. 350mA

Failure mode	Material level	Output signal	LED indicators	
			PWR	SIG
MAX			☀ O.S. ☀ F.S. ○	
			☀ O.S. ○ F.S. ☀	
MIN			☀ O.S. ☀ F.S. ○	
			☀ O.S. ○ F.S. ☀	
Instrument failure			☀	☀

R: External load
U ~ max. 250Vac@I_L ~ max. 6A
U = max. 28Vdc@I_L = max. 6A

☀ : ON ☀ : Flash ○ : OFF

WIRING INSTRUCTIONS (SC38 & SC39)

Dual MOSFET Output (SC39 only)

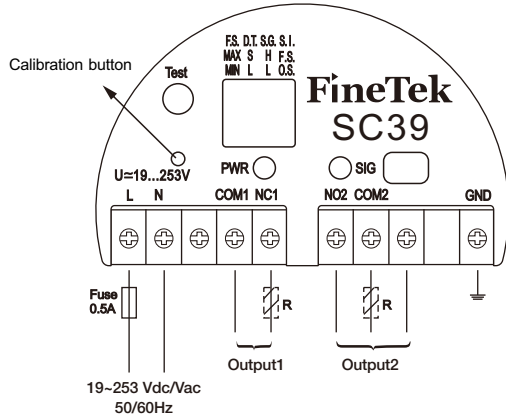

Load: External load
 $U \sim \text{max. } 60\text{Vac} @ I_L \sim \text{max. } 350\text{mA}$
 $U = \text{max. } 60\text{Vdc} @ I_L = \text{max. } 350\text{mA}$
 ※ External load R must be connected

Failure mode	Material level	Output signal	LED indicators
MAX		NO1 → I _L → COM1 NO2 → I _L → COM2	☀ O.S. ☀ F.S. ○
		NO1 → <100mA → COM1 NO2 → <100mA → COM2	☀ O.S. ○ F.S. ☀
MIN		NO1 → I _L → COM1 NO2 → I _L → COM2	☀ O.S. ☀ F.S. ○
		NO1 → <100mA → COM1 NO2 → <100mA → COM2	☀ O.S. ○ F.S. ☀
Instrument failure		NO1 → <100mA → COM1 NO2 → <100mA → COM2	☀ ☀
Over Load (I _L >350mA)		NO1 → <100mA → COM1	Maintain the previous state ☀ Maintain the previous state
Output2>350mA		NO2 → <100mA → COM2	Maintain the previous state ☀ Maintain the previous state
Output1 & Output2>350m		NO1 → <100mA → COM1 NO2 → <100mA → COM2	☀ ☀

I_L : Load current ☀ : ON ☀ : Flash ○ : OFF

TUNING AND INDICATION DETAILS

FORK TRIGGER POINT

SC14/15/16/17/24 fork trigger point is shown as below figure.

The testing medium is water(S.G.=1 g/cm³), and its trigger point is about 23mm from the fork tip. If testing medium with S.G (specific gravity) lower than 1g/cm³ (water), the trigger point would increase. Similarly, the trigger point will downward while the S.G is large than water.

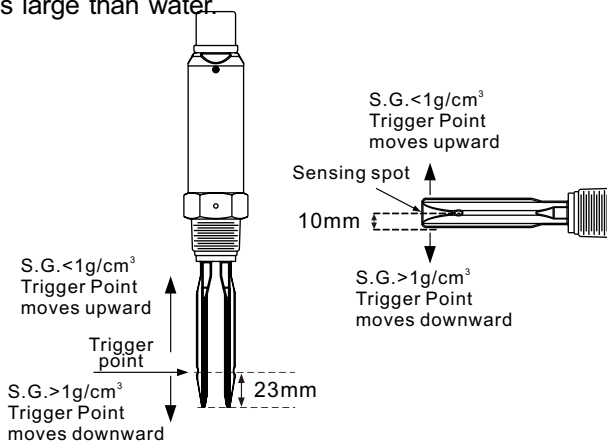

MAGNETIC TEST

After the switch is installed and powered, magnetic test function can be performed accordingly. The testing point is marked on the housing label. User holds the magnet and moves it close to testing point, the output status will switch from NO. to NC. or NC to NO. and red LED would switch ON or OFF while fork continues to vibrate. When magnet is pulled away from the testing point, the output status and red LED would return as default while fork continues to vibrate. The purpose of testing is to confirm the wiring and functioning are correct.

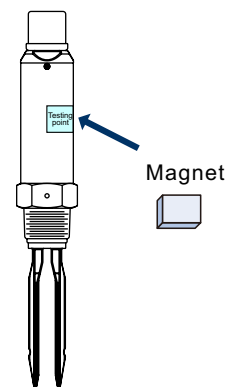

Output Status for Relay

Low (Min.) Mode: Tuning fork switch will be active after 3 seconds while power on. Relay is on NO status and red LED indication is off. When tuning fork is covered by testing medium, the vibration will stop and relay becomes NC status. Red LED indication then is on.

High(Max.) Mode: Tuning fork switch will be active after 3 seconds while the power on. Relay is on NC status and red LED indication is on. When tuning fork covered by testing medium, the vibration stops and relay becomes NO status. Red LED indication is on.

⊙ Flashing red indicates abnormal: Possible causes overloads or short-circuit load back, equipment malfunction or wear tuning fork probe.

	Min. Mode		Max. Mode		
Level					Instrument failure
Contactless electronic switch					
Red LED					

It represents Blinking

Output Status for PNP / NPN Transistor

Low(Min.) Mode : Tuning fork switch will be active after 3 seconds while power on. Output transistor is on NO status and red LED indication is off. When tuning fork covered by testing medium, vibration will stop and output transistor becomes NC status. Red LED indication is on.

High(Max.) Mode: Tuning fork switch will be active after 3 seconds while power on. Output transistor is on NC status and red LED indication is on. When tuning fork covered by testing medium, vibration will stop and output transistor becomes NO status. Red LED indication is off.

⊙ Flashing red indicates abnormal: Possible causes overloads or short-circuit load back, equipment malfunction or wear tuning fork probe.

	Min. Mode		Max. Mode		
Level					Instrument failure
PNP/ NPN Output					
Red LED					

It represents Blinking

DESCRIPTION OF FEATURES (SC35)

PANEL INTRODUCTION

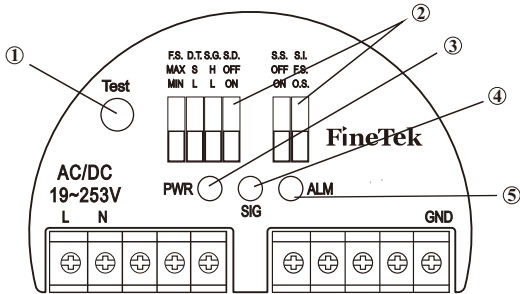

- ①: Test button
- ②: Function adjustment button
- ③: Power indicator
- ④: Status indicator
- ⑤: Alarm indicator

Abbreviation	Function	Option Description	Remarks
Test	Test button	Reverse the signal output	It is for the test after the installation is completed.
F.S.	Fail-Safe	MAX: High MIN: Low	It is for the high and low Fail-Safe mode.
D.T.	Delay Time	S: General setting L: Delay for 5 seconds	Covered by material: 0.5s Not covered by material: 150°C: ≤1.5s 230°C/280°C: ≤2s Switch to L to set it at 5 seconds for either covered or not covered by material.
S.G.	Specific Gravity	H: ≥0.05 g/cm ³ L: ≥0.01 g/cm ³	The switch to set the material density.
S.D.	Self Diagnosis	OFF: Disabled ON: Enabled	Detect the wear of the tuning fork or the viscous material and control the ON/OFF of the alarm indicator
S.S.	Super Switch	OFF: Disabled ON: Enabled	Switch the second set of output switch to the alarm indicator of the wear of the tuning fork or the viscous material for output
S.I.	Signal Indication	F.S.: Fail-Safe mode O.S.: Output mode	Turn ON/OFF the yellow indicator based on the output status or the fail-safe status.

SEDIMENT DETECTION

- It is only used to detect the sediment under the water, but can't be used for the level detection of the liquid or the doped liquid.
- S.G. (Specific Gravity) shall be adjusted to H position.
- S.D. (Self Diagnosis) shall be switched to OFF position.
- SC352 cable type is inapplicable to this working environment

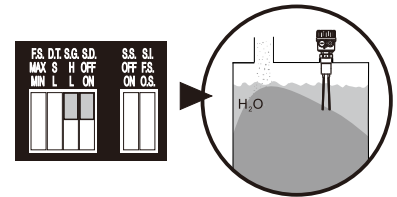

ENVIRONMENT/PROCESS TEMPERATURE LIMITATION

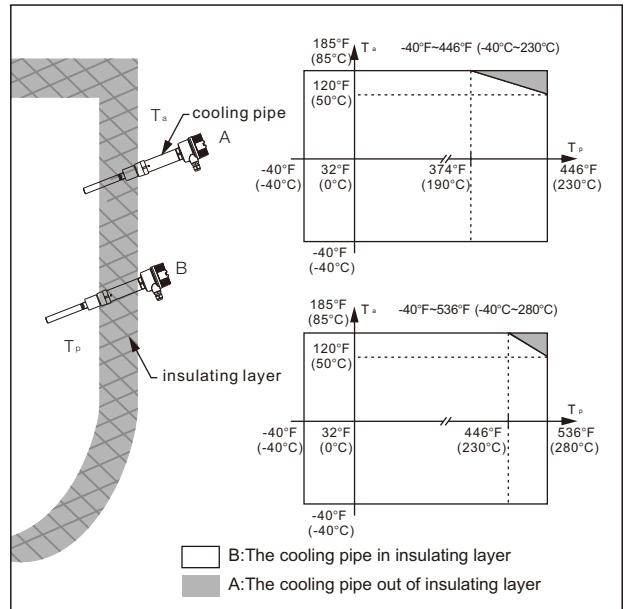
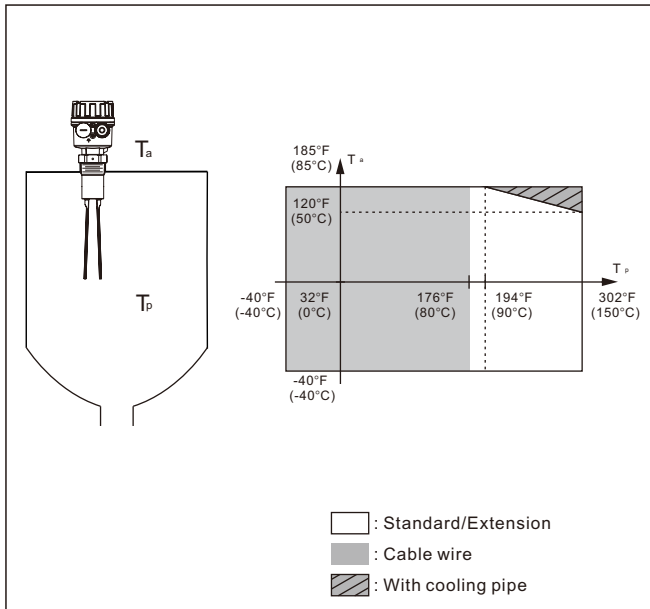

- ※ ETFE coating: T_p max. = 150°C
- ※ PTFE coating: T_p max. = 230°C

DESCRIPTION OF FEATURES (SC38 & SC39)

PANEL INTRODUCTION

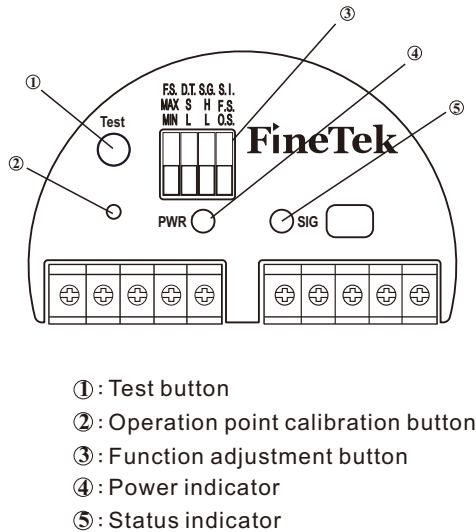

Abbreviation	Function	Option Description	Remarks
Test	Test button	Reverse the signal output	It is for the test after the installation is completed.
F.S.	Fail-Safe	MAX: High MIN: Low	It is for the high and low Fail-Safe mode.
D.T.	Delay Time	S: General setting L: Delay for 5 seconds	Covered by material: Approx. 0.5s Not covered by material: Approx. 1s Switch to L to set it at 5 seconds for either covered or not covered by material.
S.G.	Specific Gravity	H: $\geq 0.7 \text{ g/cm}^3$ L: $\geq 0.5 \text{ g/cm}^3$	The switch to set the material density.
S.I.	Signal Indication	F.S.: Fail-Safe mode O.S.: Output mode	Turn ON/OFF the yellow indicator based on the output status or the fail-safe status.

DESCRIPTION OF THE TEST BUTTON

This button is mainly provided for the user to check whether the output operation works normally after the installation is completed. When the button is pressed, the output current (8mA \leftrightarrow 16mA) and indicator (ON \leftrightarrow OFF) will be reversed. Once the button is released, it will recover the original status.

FUNCTION OF CUSTOMIZED OPERATION POINT POSITION

SC38 & SC39 provides the function of customizing the operation point position according to what is required by the user.

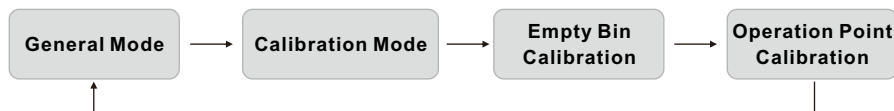

Settings

1. Keep pressing “Calibration Button” for 3 seconds. When the red and green LED indicators flash in turn every 0.5 second, it enters the calibration mode. Press the calibration button again to enter the Empty Bin Calibration mode.

[Empty Bin Calibration]

2. Calibration status: The red LED indicator flashes every 0.5 second, and the output current switches to operate every 0.5 second (8 \leftrightarrow 16mA).

3. This mode is to calibrate the vibration frequency of the tuning fork in the air. Thus, it shall press “Calibration Button” when the tuning fork doesn’t sense any material. In this case, it will write the vibration frequency in the air, and enter the operation point calibration mode.

[Operation Point Calibration]

1. Calibration status: The red LED indicator flashes every 0.25 second, and the output current switches to operate every 0.25 second (8 \leftrightarrow 16mA).

2. Cover the material to the desired operating point position under this mode, and then press “Calibration Button”. It will be adjusted to the corresponding operating point position according to the H/L setting of the S.G.

DESCRIPTION OF FEATURES (SC38 & SC39)

FORK TRIGGER POINT

The position of the SC38 & SC39 fork trigger point depends on the mounting position as shown in the figure below: (When the testing medium is water, S.G.=1 g/cm³, temperature is 23°C, and working pressure is 0 Bar). If the testing medium has an S.G. lower than 1g/cm³, the trigger point would rise. Similarly, the trigger point will move downward while the S.G. is greater than water. The moving distance is subject to the S.G.

※Operating point position: ◀

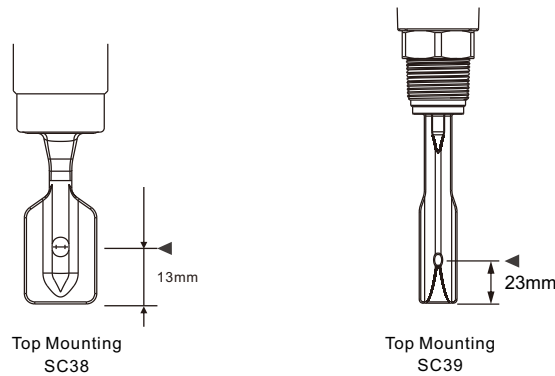

ENVIRONMENT AND PROCESS TEMPERATURE LIMITATION

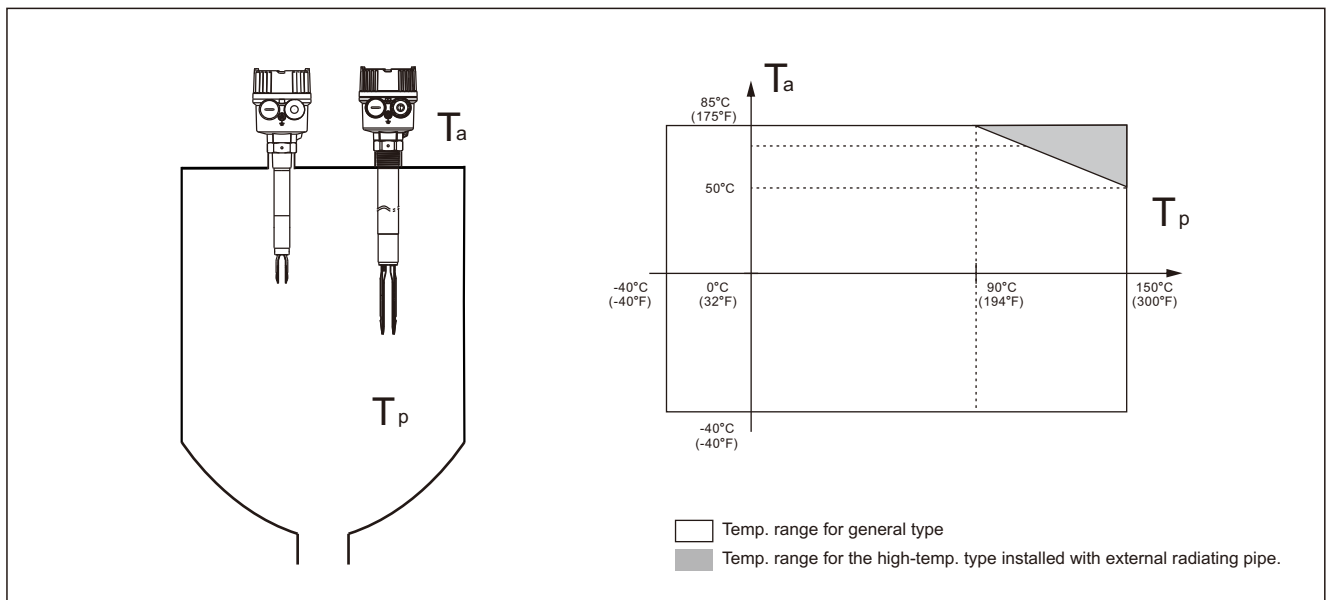

ORDER INFORMATION

SC () ()

Order No. _____

- 1400: Tuning Fork Standard Type
- 1410: Tuning Fork Ultra Extension Type
- 1420: Tuning Fork Extension Type
- 1540: Tuning Fork Corrosion Proof Type
- 1600: Tuning Fork Sanitary Type
- 1740: Explosion Proof Tuning Fork Standard Type
- 1741: Explosion Proof Tuning Fork Ultra Extension Type

Power & output module _____

- 20~250Vac/ Vdc, 50/60Hz
- R: Relay O/P-EuroType
- N: SSR(MOSFET) EuroType
- Q: Relay O/P x 2 -EuroType
- M: SSR(MOSFET) x 2 -EuroType

Material (wetted part) _____

- 0: SUS304 6: SUS316 L: SUS316L
- A: Stainless steel+PFA E: Stainless steel+ECTFE(black)
- ※ The max probe length is 400mm When item A, E, is selected
- ※ SC17 series unselectable surface coating.

Connection _____

Dimension	Specification
D---1"(25A)	M---5kg/cm ² Y---PN 25
3---1-1/4"(32A)	N---10kg/cm ² Z---PN 40
E---1-1/2"(40A)	O---150 Lbs S---others
F---2"(50A)	P---300 Lbs 9---Sanitary
G---2-1/2"(65A)	Q---PT
H---3"(80A)	R---PF(G)
I---4"(100A)	T---BSP
J---5"(125A)	U---NPT
K---6"(150A)	W---PN 10
S---others	X---PN 16

Probe length (l) (unit: mm) _____

- 0500: below 500mm
- 1000: 501~1000mm
- 1500: 1001~1500mm ※ 500mm per Unit
- ⋮

Before you order

1. Please affirm the voltage.
2. Please affirm the mounting positions.
3. Please affirm the material specific gravity (S.G.) value.
4. Please affirm whether any bridge block or vibrating motor are attached onto the silo wall.

Tolerance of the total product length is ±5mm
 Characteristics, specifications and dimensions are subject to change without notice.
 Please contact your nearest distributing office for further information.

ORDER INFORMATION

SC (T) - ()

Order No. _____

24: 100mm 28: 40mm

Power & output module _____

- 0: 20~250Vac / Vdc 2 wire Contactless electronic switch.
- 1: 12~55 Vdc 3 wire PNP/ NPN Output.

Material (wetted part) _____

- 0: SUS304
- 6: SUS316
- L: SUS316L
- A: Stainless steel+PFA
- E: Stainless steel+ECTFE(black)

Model _____

- 0: Standard 1: Extended

High temperature (150°C) _____

Electrical connection _____

- A: M12x1(180°) B: M12x1(90°)
 - C: CABLE D: Valve plug DIN43650
- (M12x1/ CABLE Wire length are 2M,PVC 24AWG)

Connection _____

Dimension	Specification	
C---3/4"(20A)SC28 only	M---5kg/cm ²	X ---PN16
D---1"(25A)	N---10kg/cm ²	Y ---PN25
E---1-1/2"(40A)	O---150 Lbs	Z ---PN40
F---2"(50A)	P ---300 Lbs	S ---Special
G---2-1/2"(65A)	Q---PT	
H---3"(80A)	R---PF(G)	
I---4"(100A)	T ---BSP	
J---5"(125A)	U---NPT	
K---6"(150A)	W---PN10	
S---Special		

Probe length (unit: mm) _____

Max Length:250mm
EX: 0250 :250mm

Before you order

1. Please affirm the voltage.
2. Please affirm the mounting positions.
3. Please affirm the material specific gravity (S.G.) value.
4. Please affirm whether any bridge block or vibrating motor are attached onto the silo wall.

Tolerance of the total product length is±5mm
Characteristics, specifications and dimensions are subject to change without notice.
Please contact your nearest distributing office for further information.

※ Material Code A and B,limited to SC1710, SC2120 these products.

ORDER INFORMATION (SC35)

SC35 **0**

Probe type

0: Standard 1: Extended 2: Cable

Power & output module

C: 19~253Vdc/Vac 50/60Hz
 Two relay output: 6A 250Vac/6A 28Vdc
 D: 19~253Vdc/Vac 50/60Hz
 Two transistor output: 350mA 60Vac/Vdc
 F: 3 wires NPN/PNP transistor output

Certification

00: None certification, 1/2"PF
 01: None certification, 1/2"NPT
 31: NEPSI dust and ex-proof, 1/2"NPT

Connection

	Dimension	Specification
Threaded	E---1-1/2"(40A) J---5"(125A)	Q---PT(R)threaded tub U---NPT threaded tub
	F---2"(50A) K---6"(150A)	R---PF(G)threaded tub S---Special
	G---2-1/2"(65A) S---Special	T---BSP threaded tub
Flange	H---3"(80A)	M---5 kg/cm ² P---300 Lbs X---PN 16
	I---4"(100A)	N---10 kg/cm ² L---600 Lbs Y---PN 25
		O---150 Lbs W---PN 10 Z---PN 40

Process temperature limitation

Type	SC350 Standard Type	SC351 Extension Type	SC352 Cable Type
80°C			4
150°C	0	2	
230°C(High-temp type)	1	3	
280°C(High-temp type)	5	6	

※Tp: Process temperature

Fork length and measurable powder density range

0: 155mm min. ≥0.01 g/cm³

Material and surface roughness

0: SUS316L, Ra≤3.2um 1: SUS316, Ra≤3.2um 2: SUS304, Ra≤3.2um

Surface coating material

0: No coating 2: ECTFE 3.PTFE

※The max probe length is 400mm When item 2, 3, is selected

Probe length (unit: mm)

xx: Standard length	A0: 9501~10000 mm	SS: Length for special specification
05: 500 mm or below	A1: 10001~11000 mm	
10: 501~1000 mm	⋮	Standard Type: It only supports xx standard length
⋮	A9: 18001~19000 mm	Extension Type: Max length is 4m
95: 9001~9500 mm	B0: 19001~20000 mm	Cable Type: Max length is 20m

ORDER INFORMATION (SC39)

SC39 0

Probe type

0: Standard 1: Extended

Power & output module

- C: 19 ~253Vdc/Vac, 50/ 60Hz
Two Relay output 6A 250Vac/ 6A 28Vdc
- D: 19 ~253Vdc/Vac, 50/ 60Hz
Two transistor output:350mA 60Vac/Vdc
- F: 10~55Vdc PNP/NPN output
- G: 11~36Vdc 8/16mA output

Certification code

0: None

Conduit specification

0: 1/2"PF 1: 1/2"NPT

Connection

	Dimension		Specification		
Threaded	D---1"(25A)	H---3"(80A)	Q---PT(R)threaded tub	U---NPT threaded tub	
	3---1-1/4"(32A)	I---4"(100A)	R---PF(G)threaded tub	S---Special	
	E---1-1/2"(40A)	J---5"(125A)	T---BSP threaded tub		
Flange	F---2"(50A)	K---6"(150A)	M---5 kg/cm ²	P---300 Lbs	X---PN 16
	G---2-1/2"(65A)	S---Special	N---10 kg/cm ²	L---600 Lbs	Y---PN 25
			O---150 Lbs	W---PN 10	Z---PN 40

Process temperature limitation

Tp	Type	SC390	SC391
		Standard Type	Extension Type
90°C@85°C (150°C@50°C)	Standard type	0	1
150°C@85°C	High temp. type	3	4

※Tp: Process temperature Ta: Operating temperature in ambient air

Material and surface roughness

- 0: SUS304, Ra≤0.3um
- 1: SUS304, Ra≤0.8um
- 2: SUS304, Ra<1.5um
- A: SUS316, Ra≤0.3um
- B: SUS316, Ra≤0.8um
- C: SUS316, Ra≤1.5um
- D: SUS316L, Ra≤0.3um
- E: SUS316L, Ra≤0.8um
- F: SUS316L, Ra≤1.5um

Surface coating material

0: No coating 2: ECTFE 3: PTFE 4: PFA

※The max probe length is 400mm When item 2, 3, 4, is selected

Probe length (unit: mm)

- XX : Standard length
- 05: Below 500 mm
- 10: 501~1000 mm
- 15: 1001~1500 mm
- 20: 1501~2000mm
- 25: 2001~2500 mm
- 30: 2501~3000 mm
- :
- SS: Length for special specifications

※Extension Type: Max length is 3m

(For other lengths, please consult the sales representative of the company)

OVERVIEW OF THE TX10 ISOLATED SAFETY BARRIER

WORKING PRINCIPLE

The barrier is provided to isolate the power supply of the transmitter in the hazardous area, which also isolates and transmits the current signal generated by the transmitter to the safe side. The maximum input is 0~20mA, and the conversion is the analogue output such as 0~20mA/4~20mA/0~5V/0~10V.

FEATURES

- 1 set of current input can be connected to the current conduction or current output product, and can be applied in the hazardous area.
- The 3 output sets are Relay output, current output and RS485. Simple user interface allows the user to judge the current device status through the LED indicators.
- Different functions can be selected with the DIP switch.
- The settings can be made upon shipment/delivery according to the customer's requirements.
- The self-diagnosis function can detect whether the system works normally any time.
- Set Relay output as Alarm mode, provide the customer with the external alarming device.
- RS485 interface is provided to set the device parameters and read the current power value.
- The new product design conforms to the ex-proof standards.
- The 2 sets of dual-color LED indicators are described as below
 PWR LED: Green LED indicates system works normally, while red LED indicates system fault.
 OUT/CHK LED: Yellow LED indicates Relay is in operation, while red flashing LED indicates input current error.

WIRING

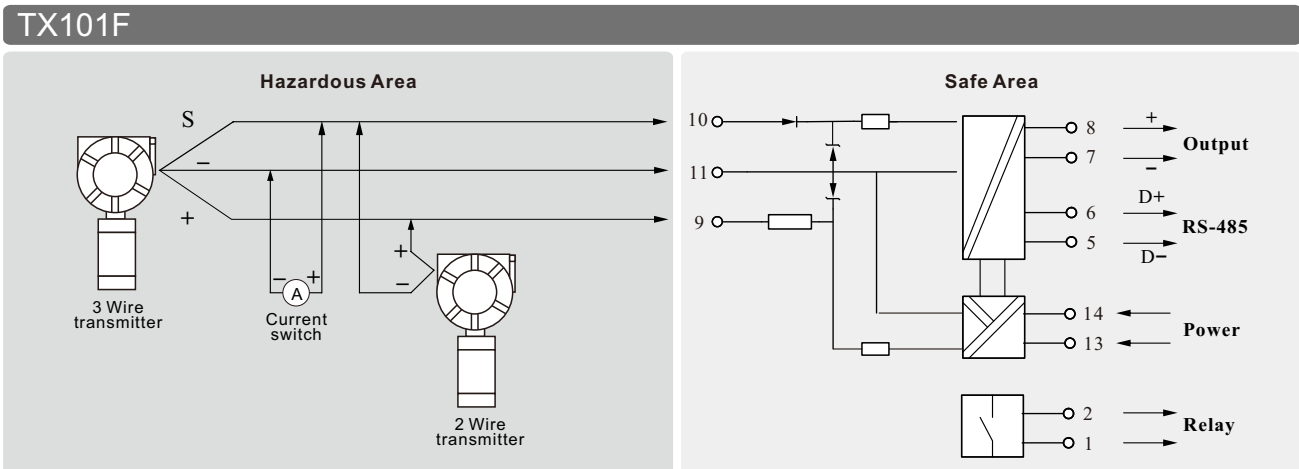
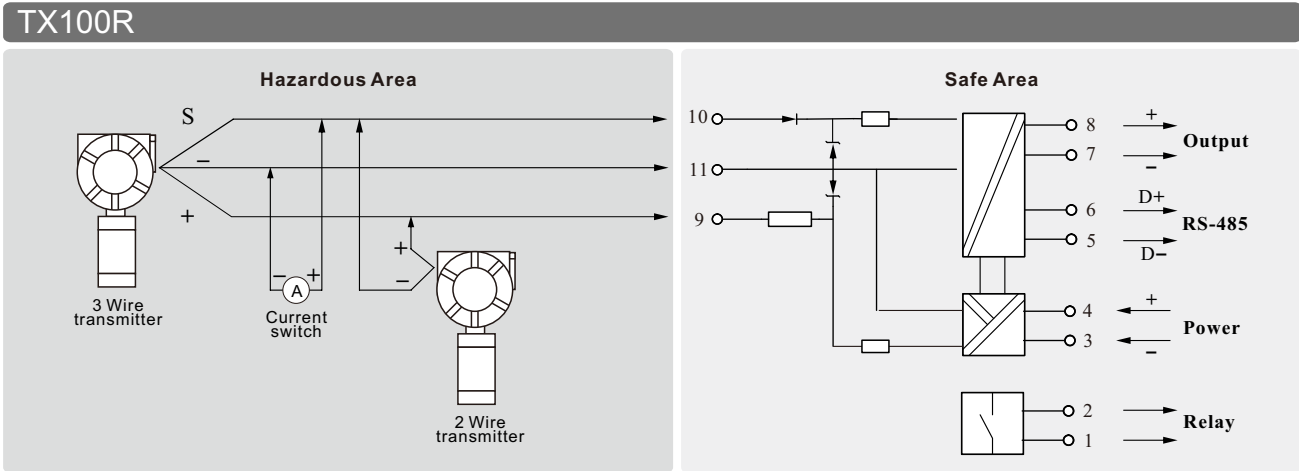

STANDARD SPECIFICATIONS

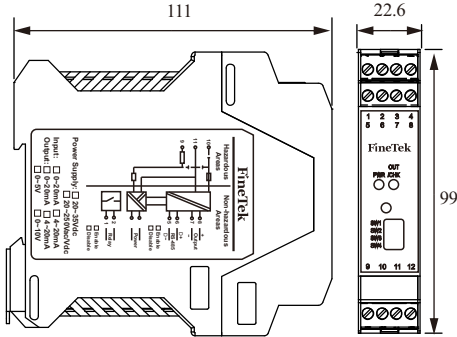
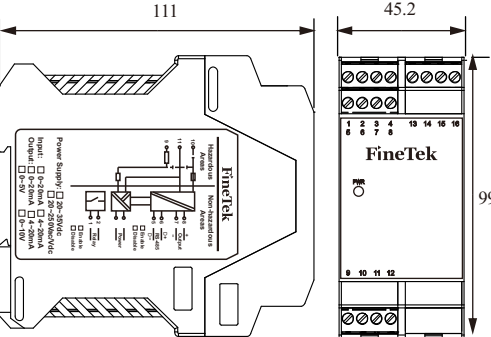
<p>Dimensions (Unit:mm)</p>		
<p>Model No.</p>	<p>TX100R</p>	<p>TX101F</p>
<p>Supply voltage</p>	<p>20~35 Vdc</p>	<p>20~250 Vdc/Vac, 50/60 Hz</p>
<p>Power supply protection</p>	<p>Reversed power supply protection</p>	<p>Non-directional input</p>
<p>Power consumption</p>	<p>< 100 mA @24 V, Load 20mA</p>	<p>< 200 mA @24 V, Load 20mA</p>
<p>Hazardous Area</p>		
<p>Current input</p>	<p>0~20/4~20</p>	
<p>Open-circuit voltage</p>	<p>< 28 Vdc</p>	
<p>Distribution voltage</p>	<p>> 15 Vdc (Load 20 mA)</p>	
<p>Safe Area</p>		
<p>Output</p>	<p>Current: 0~20/4~20 mA Load impedance: <550 ohm or Voltage: 0~5/0~10 V Load impedance: <20k ohm</p>	
<p>Reaction time</p>	<p>5 ms (Reach 90% of the final value)</p>	
<p>Transmission precision</p>	<p>0.1 % F.S.,0.5%@<0.3V (20°C)</p>	
<p>Temp. coefficient</p>	<p>< 100 ppm/°C</p>	
<p>Insulation strength</p>	<p>2500 Vac ; Leakage current <1 mA ; 1min 1. Intrinsically safe end and non-intrinsically safe end 2. Non-intrinsically safe power supply end and output end</p>	
<p>Operating temp. in ambient air</p>	<p>-20~60 °C</p>	
<p>Application environment</p>	<p>Area 0 , Area 1, Area 2, IIA 、 IIB 、 IIC T4~T6</p>	
<p>Field equipment</p>	<p>1. Two-wire sensor 2. Three-wire sensor 3. Current output sensor</p>	

ORDER INFORMATION

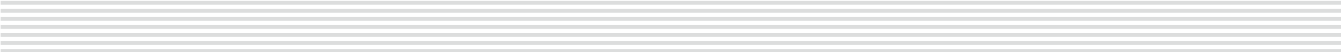

TX10

Casing and power supply type

- 0R: Wide 22.5mm, 20~35 Vdc
- 1F: Wide 45mm, 20~250 Vdc/Vac 50/60 Hz

Input type

- 2: 4~20mA
- 3: 0~20mA

Output type

- CR - 0: Current output 0~20mA
- CR - 1: Current output 4~20mA
- CV - 0: Voltage output 0~5V
- CV - 1: Voltage output 0~10V
- CRG0: Current output 0~20mA+ Relay
- CRG1: Current output 4~20mA+ Relay
- CVG0: Voltage output 0~5V+ Relay
- CVG1: Voltage output 0~10V+ Relay

Digital output

- 0: None
- 3: RS-485

Explosion certification

- EX1:NEPSI